

# SERVICE MANUAL

## FM/AM STEREO TUNER SANSUI T-80/60

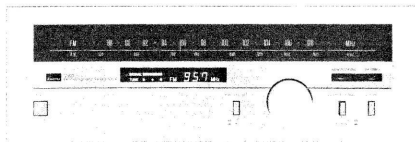

**Sansui**

SANSUI ELECTRIC CO., LTD.

**T-80/60**

### SPECIFICATIONS

#### <T-80/T-60>

##### FM Section

Tuning range	88 to 108 MHz
Usable Sensitivity	
Mono IHF	10.8 dB (1.9 $\mu$ V: T100)
DIN	1.0 $\mu$ V
Stereo IHF	21.0 dB
50 dB Quieting Sensitivity	
Mono	15.0 dB
Stereo	37.0 dB
Signal to noise ratio at 65 dB	
Mono	72 dB
Stereo	68 dB
Distortion at 65 dB	
Mono	less than 0.2% at 1,000 Hz
Stereo	less than 0.25% at 1,000 Hz
Alternate channel selectivity (at 400 kHz)	60 dB
Stereo separation	40 dB at 1,000 Hz
Frequency response	30 to 15,000 Hz +1.0 dB, -2.0 dB
Antenna input impedance	300 ohms balanced 75 ohms unbalanced

##### AM Section

Tuning range	530 to 1,600 kHz
Usable sensitivity (flat antenna)	50 dB/m (200 $\mu$ V/m)
Signal to noise ratio	45 dB
Image response ratio	45 at 1,000 Hz

##### Others

Output voltage and impedance	775 mV/2.2 kilohms
Power requirements	110 ~ 120, 220 ~ 240 V 50/60 Hz
For U.S.A. and Canada	120 V (60 Hz)
Power consumption	13 W (T-60) 19 W (T-80)
Weight	4.1 kg (9.0 lbs) net 5.1 kg (11.2 lbs) packed (T-60) 4.8 kg (10.6 lbs) net 5.8 kg (12.8 lbs) packed (T-80)
Dimensions	430 mm (16-15/16") W 147 mm (5-13/16") H 251 mm (9-15/16") D

\* Design and specifications subject to change without notice for improvements.

\* In order to simplify the explanation illustrations may sometimes differ from the originals.

T-80/60

### 1. BLOCK DIAGRAM

• T-80

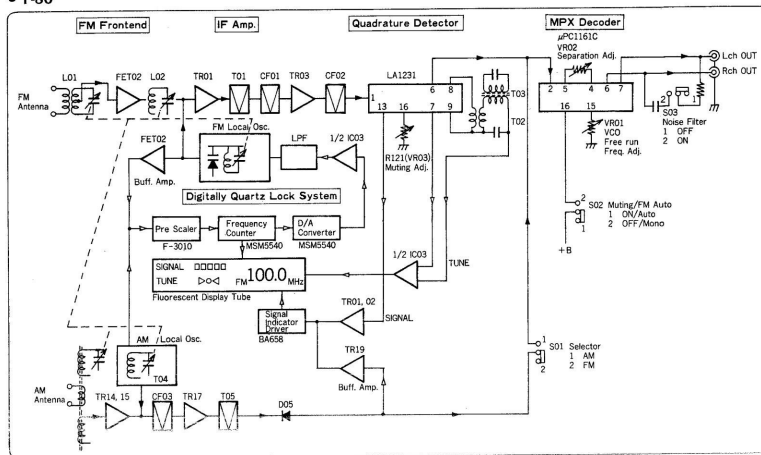

• T-60

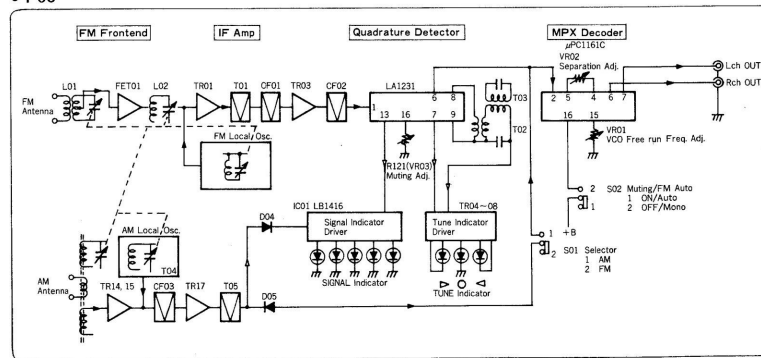

## 2. ADJUSTMENT

### 2-1. FM Adjustment (See Top View on Page 8)

- Note: 1. Selector . . . . . FM  
 2. FM MODE/MUTING Switch . . . . . MONO/OFF



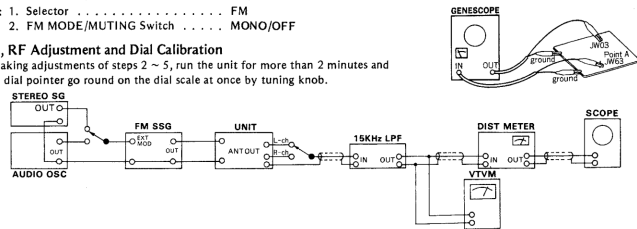

#### (1) FM IF, RF Adjustment and Dial Calibration

- Before making adjustments of steps 2 ~ 5, run the unit for more than 2 minutes and make the dial pointer go round on the dial scale at once by tuning knob.



STEP	SUBJECT	FEED SIGNAL		MEASURE OUTPUT	ADJUST	ADJUST FOR	REMARKS
		FROM	TO				
1.	IF Coil Adj. In case of using Genescope	Output 80 dB Genescope	JW03 F-3130	Point A F-3130	T01 F-3130	Max. IF waveform	
	IF Coil Adj. In case of using FM SSG & DC volt meter	98 MHz ANT Input 20 dBf (14.8 dB), 1 kHz (100% MOD) FM SSG	ANT terminal 300Ω	Voltage between Point A and chassis DC volt meter	Same as above	Max. Indication of DC volt meter Meter Range 3V	
	Discriminator Coil Adj. In case of using Genescope	Output 80 dB Genescope	Same as above	JW63 F-3130	T02, T03 F-3130	Steep linearity of S curve Make symmetrical S curve	
		No Input		Voltage between TP02 & TP03 F-3130	T02 F-3130	DC 0 V ±0.1 V	
	Discriminator Coil Adj. In case of using Dist meter	98 MHz ANT Input 65 dBf (59.8 dB), 1 kHz (100% MOD) FM SSG	ANT terminal 300Ω	OUTPUT L-CH or R-CH Dist Meter VTVM & Scope	T02, T03 & T01 F-3130	Min. THD	
		No Input		Voltage between TP02 & TP03 F-3130	T02 F-3130	DC 0 V ±0.1 V	
3.	AFC Voltage Adj. <T-80 Only>	No Input		Voltage between TM20 & TM25 F-3130	VR03 F-3000	DC 7 V	Note: As for T-80, steps 3, 4 & 5 should be performed after grounding the collector of TR15 on F-3000
4.	106 MHz Dial Calibration <T-80>	No Input		Dial Pointer	Tuning knob	106 MHz	
				Indication of Display unit	TC03 F-3130	106 MHz	
	106 MHz Dial Calibration <T-60>	106 MHz ANT Input 0 dBf (-5.2 dB), 1 kHz (100% MOD) FM SSG	ANT terminal 300Ω	OUTPUT L-CH or R-CH VTVM & Scope	TC03 F-3130	Max. Output	
5.	90 MHz Dial Calibration <T-80>	No Input		Dial Pointer	Tuning knob	90 MHz	
				Indication of Display unit	L04 F-3130	90 MHz	
	90 MHz Dial Calibration <T-60>	90 MHz ANT Input 0 dBf (-5.2 dB), 1 kHz (100% MOD) FM SSG	ANT terminal 300Ω	OUTPUT L-CH or R-CH VTVM & Scope	L04 F-3130	Max. Output	
6.	106 MHz RF Adj.	106 MHz ANT Input Minimum value with sine wave 1 kHz (100% MOD) FM SSG	ANT terminal 300Ω	OUTPUT L-CH or R-CH VTVM & Scope	TC01, TC02 F-3130	Max. Output	

to be continued

STEP	SUBJECT	FEED SIGNAL		MEASURE OUTPUT	ADJUST	ADJUST FOR	REMARKS
		FROM	TO				
7.	90 MHz RF Adj.	90 MHz ANT Input Minimum value with sine wave 1 kHz (100% MOD) FM SSG	Same as above	Same as above	L01, L02 F-3130	Max. Output	
8.	Signal Indicator Adj. <T-80 Only>	98 MHz ANT Input 20 dBf (14.8 dB), 1 kHz (100% MOD) FM SSG	ANT terminal 300Ω	SIGNAL Indicator	VR01 F-3000	Make 3 indication segments lighting	
		98 MHz ANT Input 65 dBf (59.8 dB), 1 kHz (100% MOD) FM SSG	Same as above	Same as above	Confirm every 8 indication segment lighting		
		No Input		Same as above	Confirm only one indication segment lighting		

(2) FM STEREO Adjustment  
Note: FM MODE/MUTING Switch . . . . . AUTO/ON

STEP	SUBJECT	FEED SIGNAL		MEASURE OUTPUT	ADJUST	ADJUST FOR	REMARKS
		FROM	TO				
1.	PLL VCO Adj.	98 MHz ANT Input 65 dBf (59.8 dB) FM SSG Pilot 19 kHz (9% MOD) R (or L) Mode 1 kHz + Pilot (100% MOD) STEREO SG	ANT terminal 300Ω	Stereo indicator	VR01 F-3130	Light indicator	Adjust the VR within center of lighting level
	PLL VCO Adj. In case of using Freq. Counter	98 MHz ANT Input 65 dBf (59.8 dB) FM SSG (No MOD)	Same as above	JW90 <T-60> F-3130 Point B <T-80> F-3133 (See Fig. 2-1)	VR01 F-3130	19 kHz ± 50 Hz	
2.	Separation Adj.	98 MHz ANT Input 65 dBf (59.8 dB) FM SSG Pilot 19 kHz (9% MOD) R Mode 1 kHz + Pilot (100% MOD) STEREO SG	Same as above	OUT L-CH VTVM & Scope	VR02 F-3130	OUT -40 dB	Confirm separation L-CH → R-CH (-40 dB)
3.	Muting level Adj.	98 MHz ANT Input 15 dBf (9.8 dB) FM SSG Pilot 19 kHz (9% MOD) SUB 1 kHz + Pilot (100% MOD) STEREO SG	Same as above	Stereo indicator or OUTPUT L-CH or R-CH VTVM & Scope	R121 (VR03) F-3130	Stereo indicator turns ON or Output Signal comes out	

Fig. 2-1. Location of Point B (Measure output of VCO Signal)  
Rear View of F-3133

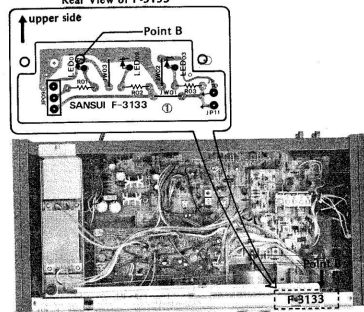

● NEW MEASUREMENT FOR FM.  
Input signal level under the provision of IHFM-T-200, a new measurement method is indicated by available power ratio "dBf". To obtain approximate available power ratio "dBf", abstract 0.8 from attenuator indication of general FMSG (open load indication type); however, the former measurement, IHFM-T-100 is designated together too.  
The way of modulation of IHFM-T-200 is shown below.

	modulation frequency	modulation mode	modulation factor
FM MONO	1000 Hz		100%
FM STEREO	1000 Hz	SUB	Pilot 9% Pilot + SUB 100%

● The relation between the standard input 65 dBf of IHFM-T-200 and the former indication "dB" is shown below.

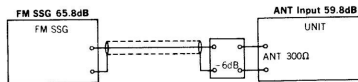

- Selection of Intermediate Frequencies (FM) (Refer to parts location F-3000 on page 6) . . . . . <T-80 Only>
- The digital locking point differs with the frequency rank of the ceramic filter used in the F-3130. When the central frequency (shown by a color) of the ceramic filter is changed, the following connection must be made by using jumper wires:
- Unify the color marks of the FM ceramic filters (CF01, CF02) on the F-3130 with the same color.
- Select the joints A, B, and C of F-3000 according to color marks as shown in the following table:

Colour	Intermediate frequency	Connecting Position of Jumper wire on F-3000			Connecting Position of Diode on F-3000					
		A	B	C	Jumper wire Total Qty	D26	D25	D24	Diode Total Qty	
Black	10.64MHz			●	1				●	1
Brown	10.66MHz		●		1			●		1
Blue	10.68MHz		●	●	2			●	●	2
Red	10.70MHz	●			1	●				1
Orange	10.72MHz	●		●	2	●		●		2
Gray	10.74MHz	●	●		2	●	●	●		2
White	10.76MHz	●	●	●	3	●	●	●		3

Fig. 2-2

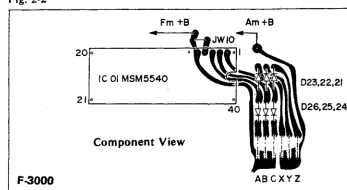

- Abbreviations
- <Equipment>
- AM FM Generator Oscilloscope . . . . . Genescope
  - AM Standard Signal Generator . . . . . AM SSG
  - FM Standard Signal Generator . . . . . FM SSG
  - FM Stereo Generator . . . . . Stereo SG
  - Oscilloscope . . . . . Scope
  - Audio Oscillator . . . . . Audio Osc.
  - Distortion Meter . . . . . Dist. Meter
- <Others>
- Antenna . . . . . ANT.
  - Modulation . . . . . MOD.
  - Total Harmonic Distortion . . . . . T.H.D.

2-2. AM IF Adjustment & Dial Calibration (See Top View on Page 8)

Note: 1. Selector . . . . . AM

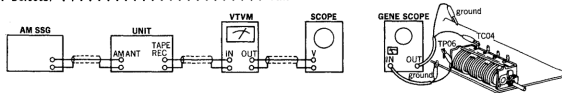

STEP	SUBJECT	FEED SIGNAL		MEASURE OUTPUT	ADJUST	ADJUST FOR	REMARKS
		FROM	TO				
1.	IF Coil Adj.	Genescope Output 60 dB	TC04 F-3130	TP06 F-3130	CF03, T05 F-3130	Max. Waveform	
2.	600 kHz Dial Calibration <T-80>	No Input		Dial Pointer	Tuning knob	600 kHz	
		600 kHz ANT Input 60 dB 400 Hz (30%MOD.) AM SSG	ANT terminal	Dial Pointer	Tuning knob	600 kHz	
3.	1400 kHz Dial Calibration <T-80>	No Input		Dial Pointer	Tuning knob	1400 kHz	
		1400 kHz ANT Input 60 dB 400 Hz (30%MOD.) AM SSG	ANT terminal	Dial Pointer	Tuning knob	1400 kHz	
4.	1400 kHz RF Adj.	1400 kHz ANT Input 50 dB 400 Hz (30%MOD.) AM SSG	Same as above	Same as above	TC04	Max. Output	

### 3. PARTS LOCATION & PARTS LIST

- As the stock number in the parts list on this service manual is indicated in 8 digit to differ from ordinary 7 digit, please be careful when ordering parts.
- Note: Parts marked X, Y or without marks indicate as follow:
  1. Parts marked X in parts list . . . . . for T-80 Only
  2. Parts marked Y in parts list . . . . . for T-60 Only
  3. Parts without marks in parts list . . . . . for both T-80 and T-60.

#### 3-1. F-3130 AM, FM, RF, IF Circuit Board (Stock No. 07062101 = T-80) (Stock No. 07056701 = T-60)

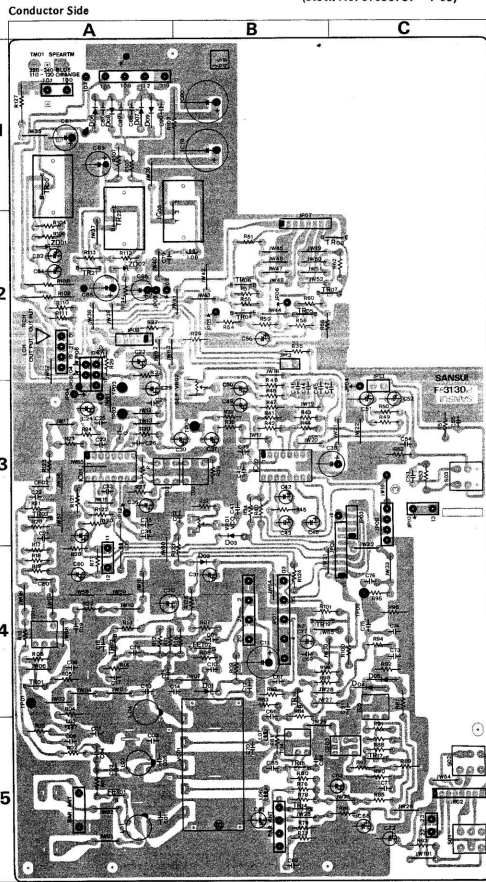

Since some of capacitors and resistors are omitted from parts lists in this Service Manual, refer to the Common Parts List for capacitors & resistors which was appended previously to each Sansui Manual.

Parts No.	Stock No.	Description	Position
<b>*Transistor</b>			
TR01	03063401, 2	2SC1614 L, K	4A
TR02, 03	03068500, 1	2SC688 C, D	4A, 3A
TR04	03068301, 2	2SC2320 E, F	2B
TR05, 06	03017700, 1	2SA498 E, F	2B
TR07, 08	03068301, 2	2SC2320 E, F	2C
TR14	03067900, 1	2SC330 C, D	5B
TR15	03047500, 1	2SA726 F, G	5B
TR16	03067900, 1	2SC330 C, D	4B
TR17	03067900, 1	2SC330 C, D	5C
TR18	03017700, 1	2SA498 E, F	4B
TR19	03034401, 2	2SB827 D, E	4B
TR20	03034401, 2	2SB827 D, E	X 2A
TR21	03068301, 2	2SC2320 E, F	X 2A
TR22	03068301, 2	2SC3313AL, D, E	3A
<b>*IC</b>			
IC 01	03612300	LA1231N	3A
IC 02	03609600	μC1181C	3B
IC 03	03609500	F57805M	X 1, 2B
<b>*FET</b>			
FET01	03703700, 1	2SK120-1, 2	X 5A
FET02	03703700, 1	2SK120-1, 2	4B
<b>*Diode</b>			
D 01	03402100	15553T	X 4B
D 02, 03	03117800	153473D	4, 4B
D 05	03117800	1N60	4C
D 06 - 09	03117700	10E-2	1A
<b>*Zener Diode</b>			
ZD01	03179100	RD13E-C	X 2A
ZD02	03179100	RD13E-C	2A
C 30	08701500	300pF 50V P.C.	3B
C 40	08504300	0.047μF 50V F.C. (M)	3B
C 41	08701700	470pF 50V P.C.	3B
C 42	08470800	1.5μF 35V T.A.C.	3B
C 43	08471000	3.3μF 35V T.A.C.	3B
C 44	08702200	750pF 50V P.C.	3B
C 45	08702200	750pF 50V P.C.	3B
C 46	08504000	0.001μF 50V F.C. (M)	3B
C 47	08504000	0.001μF 50V F.C. (M)	3B
C 48	08470500	0.22μF 35V T.A.C.	3B
C 53	08503100	0.015μF 50V F.C. (M)	3C
C 54	08503000	0.001μF 50V F.C.	3C
C 55	08503000	0.001μF 50V F.C.	3C
C 56	08502700	0.01μF 50V F.C. (M)	3B
C 73	08502700	0.01μF 50V F.C. (M)	4C
C 74	08503000	0.001μF 50V F.C. (M)	4C
C 75	08504300	0.047μF 50V F.C. (M)	4C
C 76	08504300	0.047μF 50V F.C. (M)	4C
C 88	10038600	0.0047μF 125V C.C.	1A
R 103	00052100	100Ω 3W C.e.R.	1B
R 107	00127800	15Ω 1W F.R.	X 1A
R 108	00128700	27Ω 1W F.R.	1A
R 109	00189000	330Ω 2W N.I.R.	X 2A
R 109	00189000	330Ω 2W N.I.R.	X 2A
L 01	42007200	Antenna Coil	5A
L 02	42103400	RF Coil	5A
L 03	42002900	Inductor 1.0μH	5A
L 04	42204000	OSC Coil	4A
L 05	42304000	Feeding Coil	3, 4A
L 06	49002900	Inductor 1.0μH	5B
L 08	49004000	Inductor 100μH	2B
L 09	49002200	Inductor 100μH	2B
T 01	42366300	IF Coil 10.7 MHz	4A
T 02	42362700	FM Detector Coil	3A
T 03	42362800	FM Detector Coil	3B
T 04	42201400	AM OSC Coil	5B
T 05	42306600	AM IF Coil	5C
CF 01	09104800	Ceramic Filter 10.7 MHz	4A
CF 02	09104800	Ceramic Filter 10.7 MHz	5A
	09105600	Ceramic Filter 455 kHz	5C
CF 03	09106100	Ceramic Filter 455 kHz	5C
			Y
VRO1	10370600	VCO Free Run Freq. Adj. 5±0.1B	3B
VRO2	10371100	Separation Adj. 200kΩ	(B) 3B
R121(VRO3)	10371100	Muting level Adj. 200kΩ	3A
S 01	11321500	Push Switch, AM/FM Selector, FM mode	5C
S 03	11314901	Push Switch Noise Canceller	X 3C
F 01	04312200	AC Fuse	
VC01	12203000	Variable Capacitor	
	22007000	2P Output Terminal	
	22002600	4P Antenna Terminal	

3-2. F-3000 Digitally Display Circuit Board (Stock No. 75988901 = T-80)

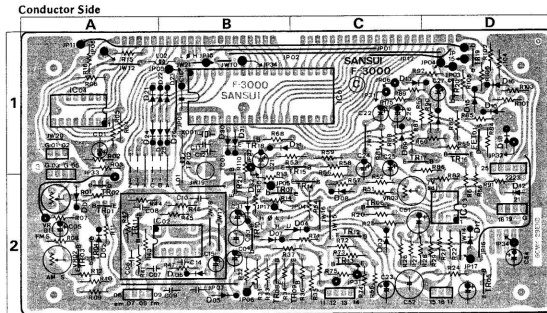

Parts No.	Stock No.	Description	Position	Parts No.	Stock No.	Description	Position	Parts No.	Stock No.	Description	Position
*Transistor				*FET				C 54			
TR01	03069601	- 3 2SC345 Q, P, K	2A	FET01	03703000	- 3 2SK117 Q, Y, GR, BL	1D	00303600	47µF 10V B.P.	2D	
TR02	03005100	- 2 2SA733A P, Q, R	2A	FET01	03704000	- 7 2SK163 K1, K2, L1, L2, M1, M2, N1, N2	1D	L 01	42900101	Choke Coil 3.5µH	
TR05, 06	03069601	- 3 2SC345 Q, P, R	2B, 2C					L 02	49001100	Inductor 100µH	
TR07	03005100	- 2 2SA733A P, Q, R	2B					VR01	10361300	FM SIGNAL Adj. 10kΩ (B) 2A	
TR08, 09	03069601	- 3 2SC345 Q, P, R	2B, 2C	D 03, 04	03111600	1S2473D	2A, C	VR03	10361100	AFC Bias Adj. 4.7kΩ (B) 2C	
TR10	03005100	- 2 2SA733A P, Q, K	2B	D 07 - 14	03111600	1S2473D	1, 2C	XC01	35300400	Crystal 6.5536-MHz	
TR12 - 18	03069601	- 3 2SC345 Q, P, K	1, 2C	D 17, 18	03111600	1S2473D	2D, 1D	FL01	03000100	Fluorescent Display Tube	
TR19	03005100	- 2 2SA733A P, Q, K	1, 2C	D 21, 24	03111600	1S2473D	1A				
TR21	03069601	- 3 2SC345 Q, P, K	1, 2C	D 30, 35	03111600	1S2473D	1D, 2C				
*IC				C 11	00304900	8µF 50V C.T.	1B				
IC 01	03609100	MSM5540RS	1B	C 12	00307200	22µF 50V C.T.	1B				
IC 03	03607100	NJMA5589	2D	C 52	00304700	33µF 15V B.P.	2C, D				
IC 04	03006300	BA956	1A	C 53	00304900	3.3µF 15V B.P.	2B				

3-3. F-3132 SIGNAL, TUNE Indicator Circuit Board (Stock No. 75989301 = T-60)

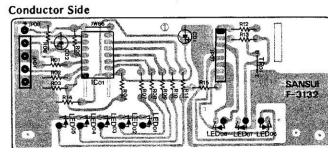

Parts No.	Stock No.	Description
*IC		
IC 01	03611600	LS1416
LED01 - 05	03193200	GL-9PR9 (Red)
LED06, 07	03193500	GL-9PR6 (Red)
LED08	03193600	GL-2PG1 (Green)

•Abbreviations

C.R. .... Carbon Resistor	E.L. .... Low Leak Electrolytic Capacitor
S.R. .... Solid Resistor	E.B. .... Bi-Polar Electrolytic Capacitor
C.A.R. .... Cement Resistor	E.B.L. .... Low Leak Bi-Polar Electrolytic Capacitor
M.R. .... Metal Film Resistor	T.C. .... Tantalum Capacitor
F.R. .... Fusing Resistor	F.C. .... Film Capacitor
N.I.R. .... Non-Inductive Resistor	M.P. .... Metallized Paper Capacitor
C.C. .... Ceramic Capacitor	P.C. .... Polyethylene Capacitor
C.T. .... Ceramic Capacitor, Temperature Compensation	C.C. .... Ceramic Capacitor
E.C. .... Electrolytic Capacitor	

3-4. F-3010 Pre Scaler Circuit Board (Stock No. 75989101 = T-80)

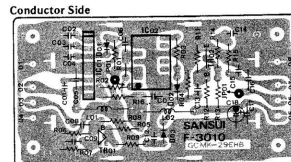

Parts No.	Stock No.	Description
*Transistor		
TR01, 02	03063401, 2	2SC1674 L, K
*IC		
IC 01	03611300	AN821
	03611200	SN74LS00N
IC 02	03613600	SN7480A
	03613700	TD34906P
*Diode		
D 01 - 03	03111600	1S2473D
L 01, 02	42900101	Choke Coil 3.5µH

• The circuit boards, F-3131 & F-3133 are not supplied as the assembled, the individual parts on the circuit boards, however are provided for orders.

3-5. F-3131 Power Switch Circuit Board

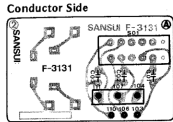

**Parts List**

Parts No.	Stock No.	Description
S 01	11323100	Push Switch, power, 25V, 1A
	11323000	Push Switch, power, 25V, 1A

3-6. F-3133 Stereo Indicator Circuit Board

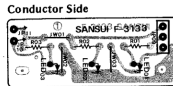

**Parts List**

Parts No.	Stock No.	Description
LED01	03193200	GL-6PR9 (Red), Stereo AM
LED02	03193300	GL-6NG9 (Green), FM
LED03	10319300	GL-6NG9 (Green), Quartz Locked
	03193200	GL-6PR9 (Red), Stereo

• Block Diagram of LA-1231 & μPC1161C

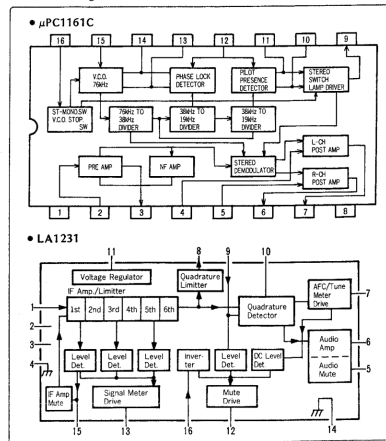

4. REPLACEMENT OF DIAL CORD

- If a dial cord is cut off or slips, replace it by following procedures. As this unit uses 0.5 mmφ cord, please replace it with the same type certainly.
- The length of dial cord is approximately 215 cm (84.6 inch).

4-1. Threading of Dial Cord

- <T-80/60>
- Thread the dial cord in numerical order from ① to ⑪ as Fig. 1.
  - Close the variable capacitor completely.
- \* Dial Cord (0.5 mmφ) . . . . . (Stock No. 6036050)

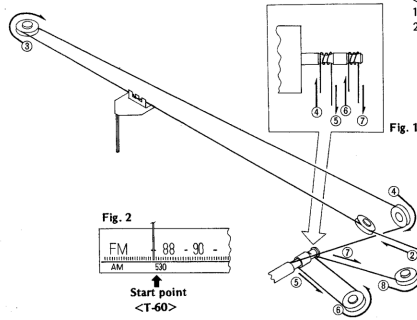

4-2. Attachment of Dial Pointer

- <T-80>
- After installing the dial string, turn on the power switch. If the dial digital display is in the "FM Reception" state, turn the tuning knob until the digital display indicates 98.0 MHz. Then, fix the pointer to the dial string, after setting the pointer to the 98.0 MHz value of the scale.
  - After attaching Dial pointer confirm Dial pointer moves from 88 MHz to 108 MHz to turn the tuning knob.
- <T-60>
- Close the variable capacitor completely.
  - Set the dial pointer to the start point, the line at the left end of the dial scale. (Fig. 2)
- \* Confirm that the dial pointer runs smoothly on the dial scale by turning the turning shaft.



**T-80/60 T-80/60**

**5. OTHER PARTS**

• Since there are black & silver models in T-80 & T-60, please pay attention when ordering parts.  
 Parts marked (S) in parts list ..... for silver model only  
 Parts marked (B) in parts list ..... for black model only

5-1. Front View <T-80>

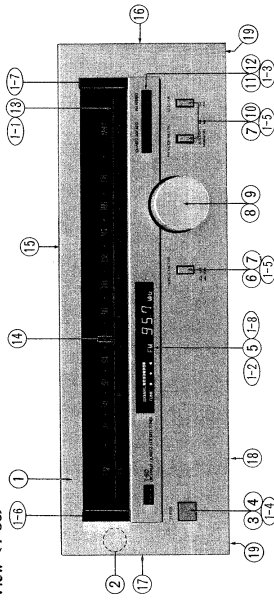

Part No.	Stock No.	Description	Part No.	Stock No.	Description
1	7208100	Front Panel Assy (S)	10	7208700	Tuning Unit (S)
2	5420500	Lamp 20V, 0.12A	11	0128200	Push Knob (S) power
3	0319000	Smoked Glass, display window	12	0319000	Smoked Glass, display window
4	0319000	Knob Guide (S) power	13	5420500	Lamp 20V, 0.12A
5	0003000	Front Panel, FM stop	14	0319000	Knob Guide (S) power
6	0319000	Knob Guide (S) power	15	5420500	Lamp 20V, 0.12A
7	5420500	Lamp 20V, 0.12A	16	0319000	Knob Guide (S) power
8	0319000	Knob Guide (S) power	17	5420500	Lamp 20V, 0.12A
9	0319000	Knob Guide (S) power	18	0319000	Knob Guide (S) power
10	7208700	Tuning Unit (S)	19	0319000	Knob Guide (S) power
11	0128200	Push Knob (S) power	20	0319000	Knob Guide (S) power
12	0319000	Smoked Glass, display window			
13	5420500	Lamp 20V, 0.12A			
14	0319000	Knob Guide (S) power			
15	5420500	Lamp 20V, 0.12A			
16	0319000	Knob Guide (S) power			
17	5420500	Lamp 20V, 0.12A			
18	0319000	Knob Guide (S) power			
19	0319000	Knob Guide (S) power			
20	0319000	Knob Guide (S) power			

5-2. Top View <T-80>

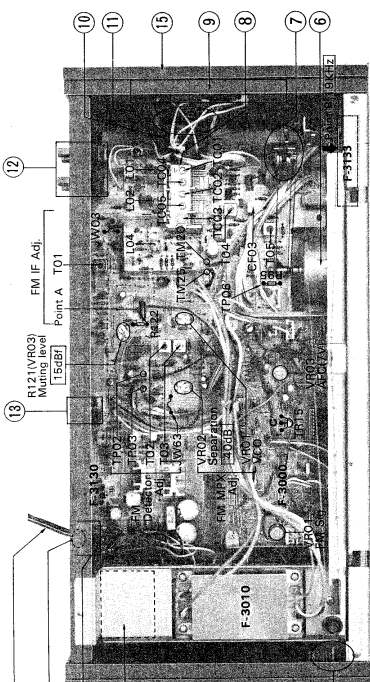

Part No.	Stock No.	Description	Part No.	Stock No.	Description
1	3802600	Power Cord 250V, 10A	7	7138100	Tension Unit
2	2402100	AC Outlet	8	5427800	Side Panel (L)
3	4201000	Variable Capacitor	9	5427800	Side Panel (R)
4	0402000	Antenna Holder	10	5427800	Side Panel (L)
5	0402000	Antenna Holder	11	5427800	Side Panel (R)
6	7208700	Tuning Unit (S)	12	2200000	2P Input Terminal
			13	2200000	2P Input Terminal

5-3. Front View <T-60>

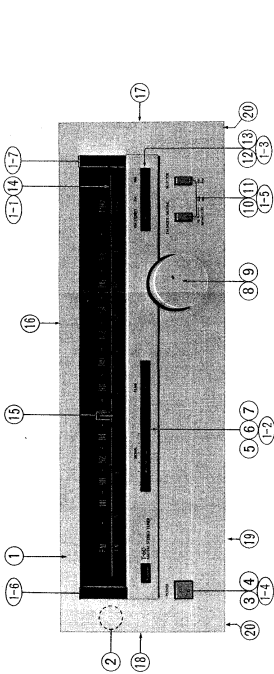

Part No.	Stock No.	Description	Part No.	Stock No.	Description
1	7208100	Front Panel Assy (S)	10	1120100	Plug Switch, FM mode & selector
2	5420500	Lamp 20V, 0.12A	11	5318410	Plug Knob (B), FM mode selector
3	0319000	Smoked Glass, display window	12	0319000	Smoked Glass, display window
4	0319000	Knob Guide (S) power	13	5420500	Lamp 20V, 0.12A
5	0003000	Front Panel, FM stop	14	0319000	Knob Guide (S) power
6	0319000	Knob Guide (S) power	15	5420500	Lamp 20V, 0.12A
7	5420500	Lamp 20V, 0.12A	16	0319000	Knob Guide (S) power
8	0319000	Knob Guide (S) power	17	5420500	Lamp 20V, 0.12A
9	0319000	Knob Guide (S) power	18	0319000	Knob Guide (S) power
10	1120100	Plug Switch, FM mode & selector	19	5420500	Lamp 20V, 0.12A
11	5318410	Plug Knob (B), FM mode selector	20	0319000	Knob Guide (S) power
12	0319000	Smoked Glass, display window			
13	5420500	Lamp 20V, 0.12A			
14	0319000	Knob Guide (S) power			
15	5420500	Lamp 20V, 0.12A			
16	0319000	Knob Guide (S) power			
17	5420500	Lamp 20V, 0.12A			
18	0319000	Knob Guide (S) power			
19	5420500	Lamp 20V, 0.12A			
20	0319000	Knob Guide (S) power			

5-4. Top View <T-60>

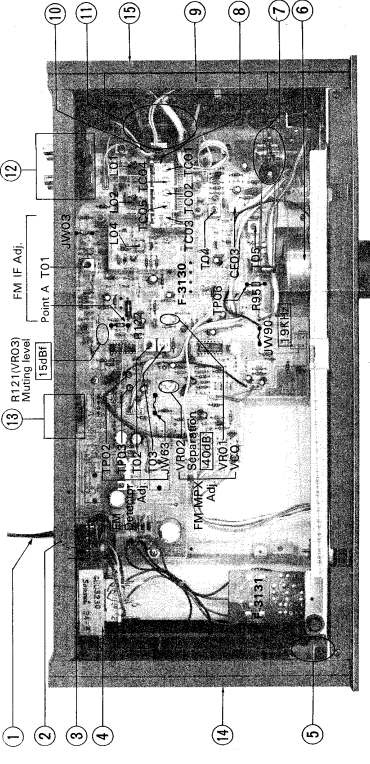

Part No.	Stock No.	Description	Part No.	Stock No.	Description
1	3802600	Power Cord 250V, 10A	7	7138100	Tension Unit
2	2402100	AC Outlet	8	5427800	Side Panel (L)
3	4201000	Variable Capacitor	9	5427800	Side Panel (R)
4	0402000	Antenna Holder	10	5427800	Side Panel (L)
5	0402000	Antenna Holder	11	5427800	Side Panel (R)
6	7208700	Tuning Unit (S)	12	2200000	2P Input Terminal
			13	2200000	2P Input Terminal

T-80/60 T-80/60

6. SCHEMATIC DIAGRAM 6-1. Tuner Section <T-80>

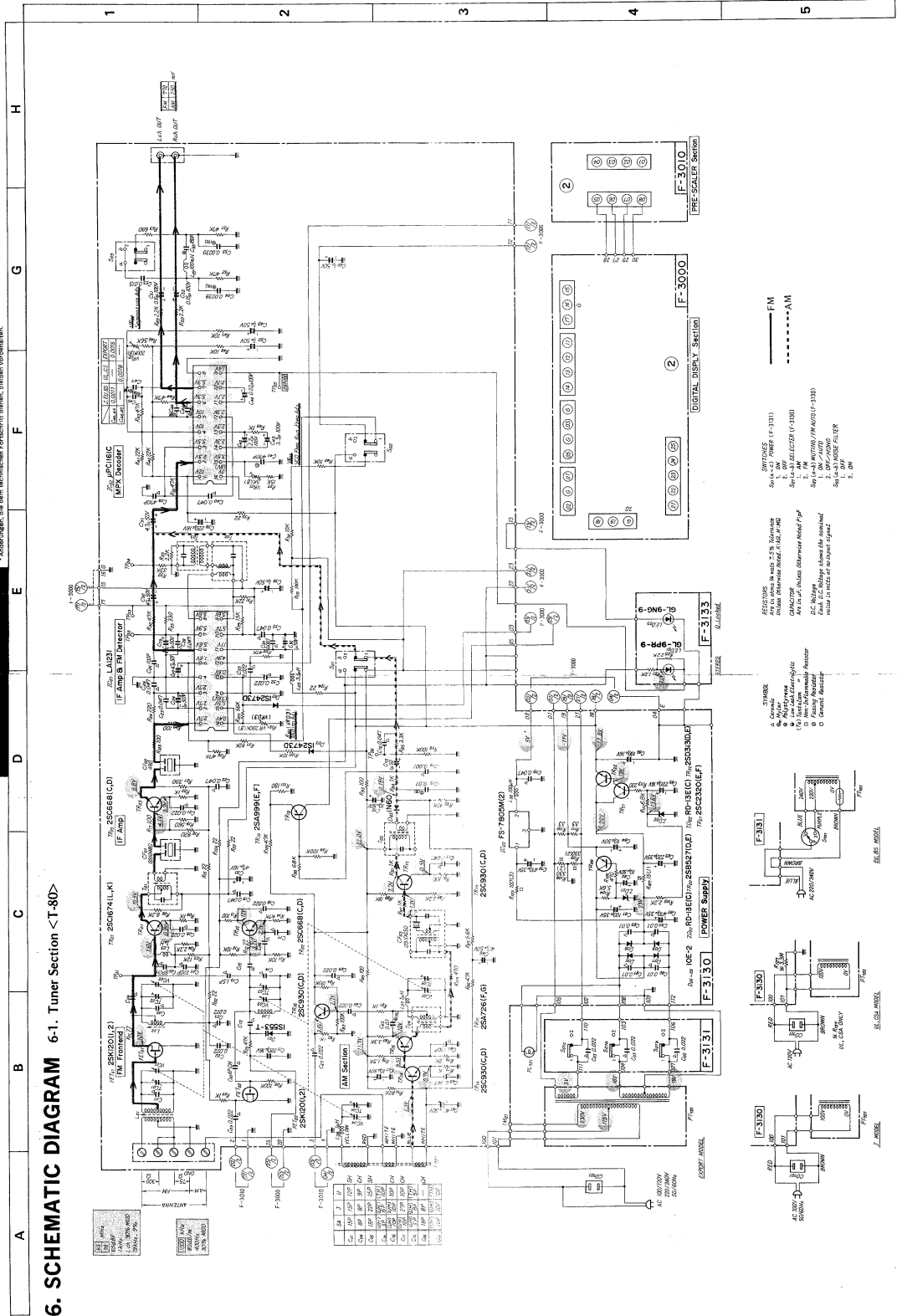

# T-80/60 T-80/60

\* Design and specifications subject to change without notice for improvement.  
 \* La conception et les spécifications sont susceptibles de modifications sans préavis pour mieux répondre aux besoins des utilisateurs.  
 \* All dimensions are in millimeters unless otherwise indicated.

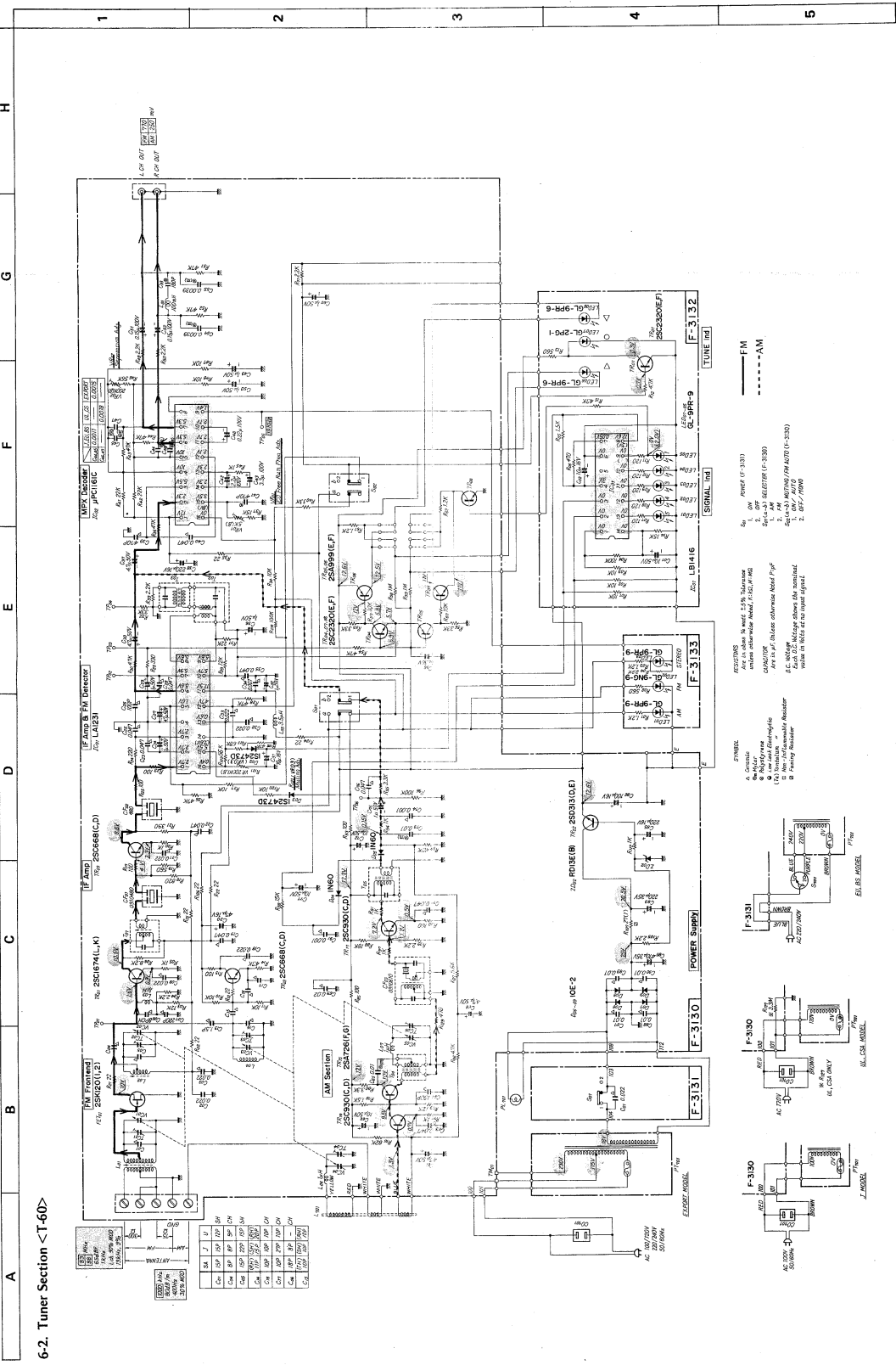

6-2. Tuner Section <T-60>

### 7. PACKING LIST

Parts No.	Stock No.	Description
1	91263800	Vinyl Cover
2	90264000	Styrofoam Packing (S)
3	90563000	Carton Case <T-80 (B)>
	90562000	Carton Case <T-80 (S)>
	90562800	Carton Case <T-80 (B)>

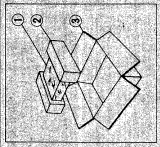

### 8. ACCESSORY PARTS LIST

Stock No.	Description
92055200	Operating Instructions <T-80>
92055100	Operating Instructions <T-60>
38207200	FM Antenna
38103200.1	P.P. Cord

Design and specifications subject to change without notice for improvement.  
 \* Änderungen, die dem technischen Fortschritt dienen, können vorbehalten sein.

6-3. Digital Display Section <T-80>

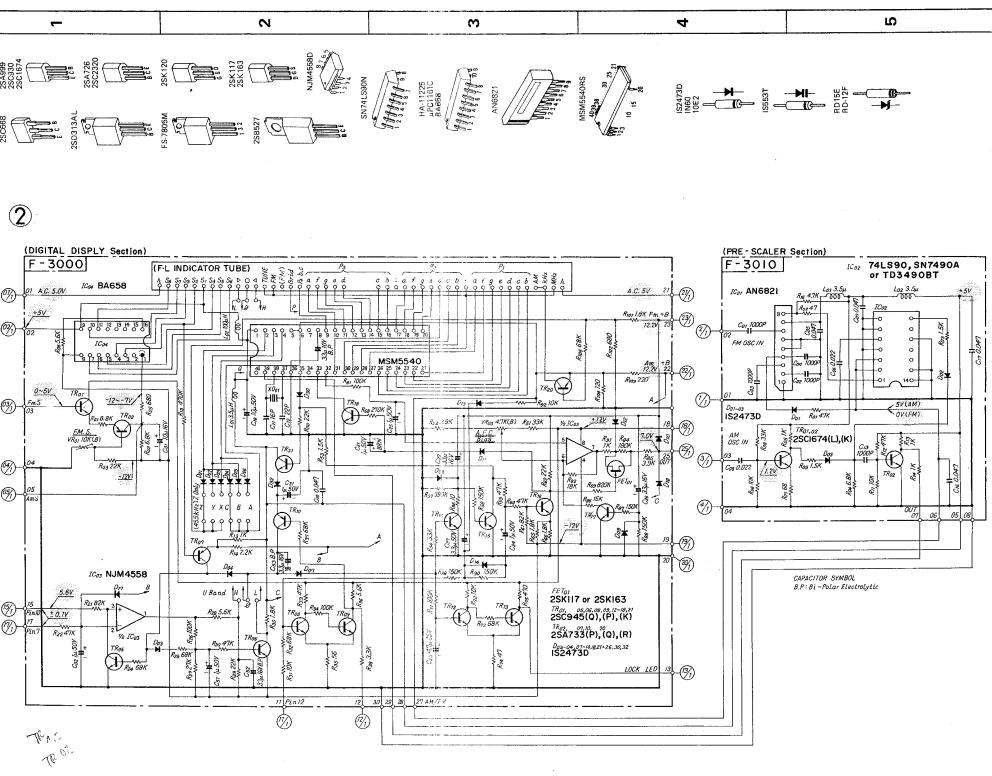

SANSUI ELECTRONICS CORPORATION: 1251 Valley Brook Ave., Lyndhurst, N.J. 07073 U.S.A.  
 SANSUI ELECTRONICS (EUROPE) LTD.: 11, The Quadrant, Watlington, Oxford, OX4 9JF, U.K.  
 SANSUI AUDIO EUROPE N.V.: North Trade Bldg. (RHS floor) Noorderplant 133 Bldg. 1, 2030 Antwerp, Belgium  
 SANSUI AUDIO EUROPE S.A.: Avenue center, 9 Frankfurt AM Main, Lyoner Strasse 44-48, West Germany  
 SANSUI ELECTRIC COMPANY LTD.: 1-1-1, Jyomji, 2-chome, Suginami-ku, Tokyo 166 Japan PHONE: (03) 333-1111 TELEX: 332-207/6  
 SMT148 Printed in Japan (897230M)